

# GROWER TIPS

## HOW TO GET MAXIMUM SERVICE FROM YOUR GREENHOUSE COVERINGS.

Aluminum locking channels are recommended for securing film to the structure. If the locking channel has a plastic liner that contains a plasticizer (or if the framework is PVC pipe), an extra layer of polyethylene film between covering and the plasticized material (or PVC pipe) will alleviate any chemical reactivity with the covering material. DIRECT CONTACT OF THE POLYETHYLENE WITH PVC PIPE IS NOT ADVOCATED.

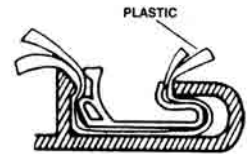

Troubled with the poly (PE) slipping in the lock? Could be the poly or, could be the lock. Try a narrow strip of PE in the lock - running the length of the house - to give extra bulk. Roughing the contact points strip of the lock with a very fine (240 or 260) sandpaper has also been found to be helpful.

2. If nails are used to secure film, it should be sandwiched between two pieces of lath. Nail through the outside lath every 6" to 8" with the nail piercing three layers of film as shown in the diagram.



It is important that a uniform tension and pressure be maintained on the PE. If the poly is not secure, a nail will not hold it. During periods of high winds, it will pull through an insecure installation. THE USE OF BATTEN TAPE AND STAPLES IS NOT RECOMMENDED BY MANUFACTURERS FOR SECURING POLY TO GREENHOUSE STRUCTURE.

3. Apply a heavy coat of an industry approved white latex paint over unpainted or treated wood. Allow the recommended curing time before covering. (Dark surfaces absorb solar heat; contact with such areas causes premature thermal degradation of the polyethylene covering.)



4. Apply two layers of sheeting or one roll of tubing to form an air space (bubble) in areas where wind imposes repeated stress. Single layer installations may not have sufficient resistance to wind damage due to repeated flexing.

5. Outside air - with its lower moisture content - is recommended for the inflation in the "bubble". Warm air - from the inside of the greenhouse - with its higher level of moisture - is a source of condensation when it is introduced into the cooler atmosphere in the "bubble". Moisture, trapped between the layers of poly, has a tendency to reduce light.



Temperatures under the inside layer of covering can reach high levels during daylight hours and there is always the possibility of thermal degradation. Inside air, oxygen rich and often heavily laden with greenhouse chemicals can be another source of premature degradation of the poly. Care should be taken to locate the inflation air intake tube at a point where it will not be blocked by snow or become filled with water. It is important - when introducing the air into the "bubble" - that it be blown in obliquely - rather than directly at the film.

Proper air pressure in the "bubble" is extremely important. Use of a simple manometer is recommended. At approximately 1/4" of water, the "bubble" is properly inflated.

6. After installation, avoid surface contact or extended exposure of the covering to herbicides, pesticides, fungicides. More specifically, bromine, chlorine, fluorine, iodine, sulphur, petroleum and/or wood preservatives containing copper.

### BEWARE OF CHEMICALS: POLY FILMS AND CHEMICALS

Listed in the chart at the right are chemicals either known to react with polyethylene and/or the HALS UV inhibitor, or suspected to have the potential to reduce film life.

Wood treated with preservatives such as Pentachlorophenol or creosote should not come into contact with the film as they may break down the UV system in the film and shorten the usable life. Pressure preservative treated wood having the markings "ACCA-CLP-22" indicated a water born method that is safe to use (i.e. Wolman™ lumber).

### CHEMICALS KNOWN TO CAUSE DETERIORATION OF POLYETHYLENE FILM:

Banrot*	Chlorothalonil*	Chlorine Bleach
Chloropiorin	Pentachloronitrobenzene	Bromoxynil
Chlorine Gas	(PNCB)	Iprodione
Chlorpyrifos	Captan*	Silver Thiosulfate
Dithiocarbamates	Diazinon*	Methomyl
Fluvalinate	Mancozeb	Metham-sodium
Vinclozolin	Copper sulfate solution	Hypochlorite swimming
Dienochlor*	Formethanate Hydrochloride	pool chemicals

*\*Trade names are used only where no generic name could be found for the chemical or combination of chemicals.*





*Sun Master Films*

## SUN MASTER® GREENHOUSE FILMS

Sun Master greenhouse films combine long life time, superior strength and high light transmission with optional characteristics that transform film to an active contributor to plant protection, growth and productivity. These features are film lifetime, superior strength, light transmission, thermal effect, anti-drip effect and light diffusion.

**Sun Master® IV-** is a 6 mil, three layer co-extruded, ultra violet stabilized for up to four years greenhouse poly which provides superior strength, 90% PAR light transmission and better film properties (folds, tears and puncture resistance).

Sizes; Tube widths 12.5', 14', 16', 18', 20', 21", 24', & 25'

Sheet widths 6', 10', 12.5', 14', 16', 18', 20', 24', 25', 28', 32', 36', 40', 42', 48', & 50'

**Sun Master® Thermal-** is a 6 mil, three layer co-extruded, ultra violet stabilized for up to four years, infra-red retention (IR) greenhouse film that provides superior condensation control by reducing the surface tension of the poly allowing condensation to roll down inside poly in stead of dripping. This product provides grower with the ability to save considerable on energy costs. Savings will easily pay for the additional cost of this product compare to normal four year film in the first year of use. Greater light diffusion when compared to normal 4 year product. 87% PAR light transmission and 58% light diffusion.

Sizes; Sheet widths 20', 24', 28', 32', 36', 40', & 50'

**Sun Master® White IV 55%-** is a 6 mil, three layer co-extruded, white greenhouse film ultra violet stabilized for up to four years with 55% opacity.

Sizes; Sheet widths 20', 24', 25', 32', 36', 40', 42', 48', & 50'

**Sun Master® OW White 70%-** is a 3mil ultra violet stabilized white overwintering film for seasonal winter protection.

Sizes; Sheet widths 14', 16', 20', 24', 28', 32', 40', & 48'

**Sun Master® OW Clear-** 3 & 4 mil ultra violet stabilized clear overwintering film for seasonal winter protection.

Sizes; Sheet widths (3 & 4 mil) 14', 16', 18', 20', 24', 28', 32', 36', 40', 42', & 48'

**Lengths for the above films can be any lengths since all rolls are cut from master rolls.** For pricing information call customer service or your sales representative.



# TUFFLITE IV™ GREENHOUSE FILM ... IT'S THE CLEAR CHOICE!

Tufflite is the original "colorless" polyethylene greenhouse covering. For over twenty years, growers have covered their income (crops) with Tufflite. Tufflite was the first multi-year product incorporating the HALS Formula System (Hindered Amine Light Stabilizer) of ultraviolet inhibitors. Tufflite brand products are produced by Berry Plastics Agricultural Films, one of North America's largest manufacturers of polyethylene products for agriculture.

### TUFFLITE IV BENEFITS:

**UV Block:** Helps to reduce the harmful effects of ultraviolet radiation while providing a more comfortable working environment.

**Anti-Dust Accumulation:** Resists dust attraction for better clarity over the life of the covering.

**Increased Chemical Resistance:** Helps to reduce the effects from greenhouse chemicals.

**High PAR Transmission:** This signature of past Tufflite products continues with Tufflite IV.

**Tufflite Infrared:** Has all the benefits of Tufflite IV as well as an additive that helps to reduce condensation buildup on the film, plus an additional additive that disperses light and helps to delay the exit of heat from the greenhouse.

### QUANTITY DISCOUNTS

3 Rolls, Less 5%

6 Rolls, Less 10%

10 Rolls, Less 15%

Call for further discounts.

*Tufflite is also available in white. It contains all the features of Tufflite IV clear. The shade produced is 55%.*

Stock No.	Size	Fold	Lbs./Roll	Price
<b>CLEAR 4MIL TUBING - 3 YEAR</b>				
2156T3414220T	14'4" x 220'	LT	126	\$316.67
<b>CLEAR 6MIL TUBING - 4 YEAR</b>				
2156T4620110T	20' x 110'	TDF	133	\$362.18
2156T4620150T	20' x 150'	TDF	180	493.88
2156T4624100T	24' x 100'	TDF	146	395.10
2156T4624110T	24' x 110'	TDF	160	434.61
2156T4624150T	24' x 150'	TDF	215	592.65
<b>CLEAR 6MIL SHEETING - 4 YEAR</b>				
2156T4610100	10' x 100'	CFF	31	\$82.31
2156T4612100	12' x 100'	CFF	36	98.78
2156T4614100	14' x 100'	CFF	42	115.24
2156T4616100	16' x 100'	CFDF	48	131.70
2156T4620100	20' x 100'	CSTF	61	164.63
2156T4620110	20' x 110'	CSTF	66	181.09
2156T4620150	20' x 150'	CSTF	90	246.94
2156T4624100	24' x 100'	CSTF	73	197.55
2156T4624110	24' x 110'	CSTF	80	217.31
2156T4624125	24' x 125'	CSTF	91	246.94
2156T4624150	24' x 150'	CSTF	108	296.33
2156T4628100	28' x 100'	CSTF	85	230.48
2156T4628110	28' x 110'	CSTF	93	253.52
2156T4628150	28' x 150'	CSTF	126	345.72
2156T4632100	32' x 100'	STDF	97	263.40
2156T4632110	32' x 110'	STDF	107	289.74
2156T4632125	32' x 125'	STDF	121	329.25
2156T4632150	32' x 150'	STDF	144	395.10
2156T4636100	36' x 100'	STDF	109	296.33
2156T4636110	36' x 110'	STDF	120	325.96
2156T4636150	36' x 150'	STDF	162	444.49
2156T4640100	40' x 100'	STDF	121	329.25
2156T4640110	40' x 110'	STDF	133	326.18
2156T4640125	40' x 125'	STDF	151	411.57
2156T4640150	40' x 150'	STDF	180	493.88
2156T4640200	40' x 200'	STDF	240	658.50
2156T4642100	42' x 100'	STDF	128	346.54
2156T4642150	42' x 150'	STDF	188	518.57
2156T4648100	48' x 100'	STDF	146	395.10
2156T4648150	48' x 150'	STDF	215	592.65
2156T4648200	48' x 200'	STDF	288	790.21
2156T4650100	50' x 100'	STDF	152	411.57
2156T4650150	50' x 150'	STDF	224	617.35
2156T4656100	56' x 100'	STDF	170	461.78

Stock No.	Size	Fold	Lbs./Roll	Price
<b>White 6mil Sheeting - 4 Year</b>				
2156T4W624100	24' x 100'	CSTF	73	\$223.24
2156T4W624150	24' x 150'	CSTF	108	334.86
2156T4W632100	32' x 100'	STDF	97	297.65
2156T4W632150	32' x 150'	STDF	144	446.48
2156T4W640100	40' x 100'	STDF	121	372.06
2156T4W640150	40' x 150'	STDF	180	558.10
<b>INFRARED</b>				
<b>6MIL TUBING - 4 YEAR</b>				
2156T4624110IRT	24' x 110'	TDF	160	\$526.09
2156T4624150IRT	24' x 150'	TDF	215	717.39
<b>6MIL SHEETING - 4 YEAR</b>				
2156T4620100IR	20' x 100'	CSTF	60	\$199.38
2156T4624100IR	24' x 100'	CSTF	73	239.13
2156T4624150IR	24' x 150'	CSTF	108	358.70
2156T4632100IR	32' x 100'	STDF	97	318.84
2156T4632150IR	32' x 150'	STDF	144	478.26
2156T4636150IR	36' x 150'	STDF	162	444.50
2156T4640100IR	40' x 100'	STDF	121	489.21
2156T4640150IR	40' x 150'	STDF	180	597.83
2156T4642100IR	42' x 100'	STDF	128	345.72
2156T4648100IR	48' x 100'	STDF	146	478.26
2156T4648150IR	48' x 150'	STDF	215	717.39

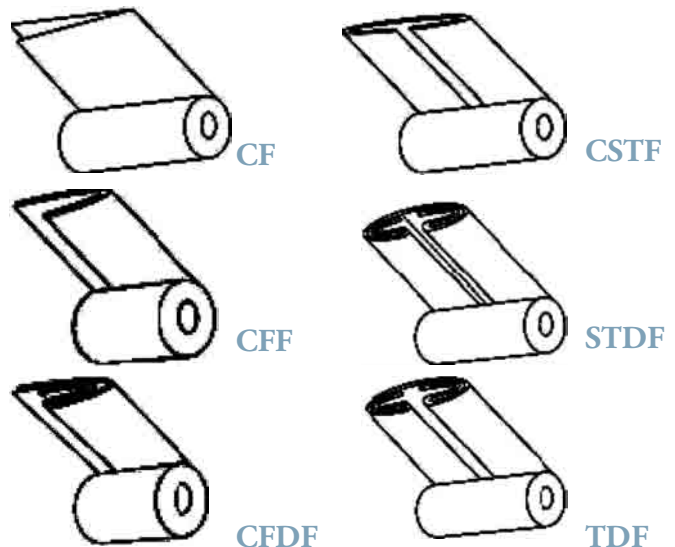

# TUFFLITE NURSERY CLEAR™

Tufflite Nursery Clear™ is a fully warranted one year covering, available in 4mil or 6mil. It contains a UV block and is dust and chemical resistant.

Stock No.	Size	Lbs./Roll	Price
<b>CLEAR 4MIL SHEETING</b>			
2156NC48220	8' x 220'	CF	35
2156NC410100	10' x 100'	CFF	20
2156NC410220	10' x 220'	CFF	45
2156NC412100	12' x 100'	CFF	24
2156NC412220	12' x 220'	CFF	53
2156NC414220	14' x 220'	CFF	61
2156NC416220	16' x 220'	CFDF	70
2156NC420100	20' x 100'	CSTF	40
2156NC420150	20' x 150'	CSTF	60
2156NC424100	24' x 100'	CSTF	49
2156NC424150	24' x 150'	CSTF	72
2156NC428100	28' x 100'	CSTF	57
2156NC428150	28' x 150'	CSTF	84
2156NC428220	28' x 220'	CSTF	123
2156NC432100	32' x 100'	STDF	65
2156NC432150	32' x 150'	STDF	96
2156NC440100	40' x 100'	STDF	81
2156NC440150	40' x 150'	STDF	120
2156NC442100	42' x 100'	STDF	85
<b>CLEAR 6MIL SHEETING</b>			
2156NC610100	10' x 100'	CFF	31
2156NC612100	12' x 100'	CFF	36
2156NC620100	20' x 100'	CSTF	60
2156NC620150	20' x 150'	CSTF	90
2156NC624100	24' x 100'	CSTF	73
2156NC624150	24' x 150'	CSTF	108
2156NC628100	28' x 100'	CSTF	85
2156NC628150	28' x 150'	CSTF	126
2156NC632100	32' x 100'	STDF	97
2156NC632150	32' x 150'	STDF	144
2156NC640100	40' x 100'	STDF	121
2156NC640150	40' x 150'	STDF	180
2156NC642100	42' x 100'	STDF	128

# C & A FILM

Stock No.	Size	Lbs./Roll
<b>CLEAR 4MIL SHEETING</b>		
2156CAN43100	3' x 100'	23
2156CAN44100	4' x 100'	23
2156CAN46100	6' x 100'	12
2156CAN48100	8' x 100'	15
2156CAN410100	10' x 100'	19
2156CAN412100	12' x 100'	23
2156CAN416100	16' x 100'	31
2156CAN420100	20' x 100'	39
2156CAN424100	24' x 100'	46
2156CAN428100	28' x 100'	54
2156CAN432100	32' x 100'	62
2156CAN440100	40' x 100'	77

*\*All above sizes are also stocked in Black 4mil Sheeting.  
Other sizes and 6mil available by special order only.  
Minimum order may apply.*

# CO-POLY™ FOR OVERWINTERING

Available in white (70% shade), Co-Poly™ is an overwintering cover for woody nursery stock and propagation houses. Available in 3mil, 4mil and 6mil.

Stock No.	Size	Fold	Lbs./Roll	Price
<b>WHITE 3MIL SHEETING</b>				
2156CW310100	10' x 100'	CFF	15	
2156CW332100	32' x 100'	STDF	48	
2156CW340100	40' x 100'	STDF	60	
<b>WHITE 4MIL SHEETING</b>				
2156CW410110	10' x 110'	CFF	22	
2156CW412110	12' x 110'	CFF	26	
2156CW424100	24' x 100'	CSTF	49	
2156CW424110	24' x 110'	CSTF	53	
2156CW424125	24' x 125'	CSTF	60	
2156CW424150	24' x 150'	CSTF	72	
2156CW424200	24' x 200'	CSTF	96	
2156CW424220	24' x 220'	CSTF	106	
2156CW428110	28' x 110'	CSTF	62	
2156CW428125	28' x 125'	CSTF	70	
2156CW432110	32' x 110'	STDF	71	
2156CW432125	32' x 125'	STDF	80	
2156CW432150	32' x 150'	STDF	96	
2156CW440100	40' x 100'	STDF	81	
2156CW440125	40' x 125'	STDF	100	
2156CW440150	40' x 150'	STDF	120	
<b>WHITE 6MIL SHEETING</b>				
2156CW624110	24' x 110'	CSTF	80	
2156CW632110	32' x 110'	STDF	107	
2156CW640110	40' x 110'	STDF	133	
2156CW640125	40' x 125'	STDF	151	

*\*Special order shade available at 33% and 55%.  
Custom sizes and 3mil available by special order.  
Minimum order may apply.*

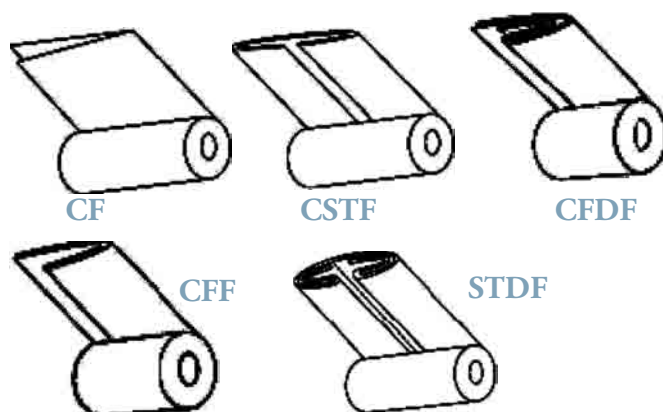

**QUANTITY DISCOUNTS**  
3 Rolls, Less 5%  
6 Rolls, Less 10%  
10 Rolls, Less 15%  
Call for further discounts.



# SPRINGLOC FASTENING SYSTEM

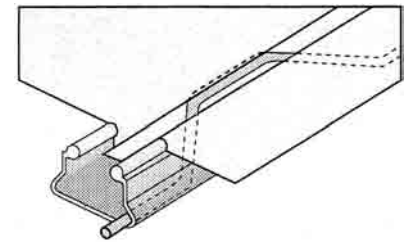
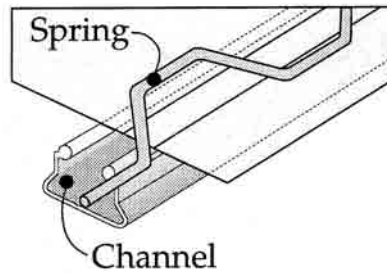
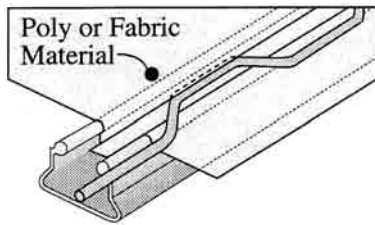

Insert enough film into the base of the Channel so the Spring will seat itself without cutting the Film.

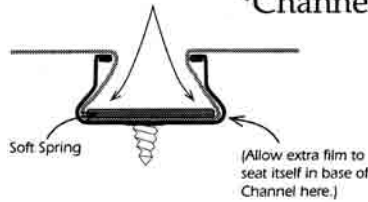

## Baseboard Application



## Gable Application

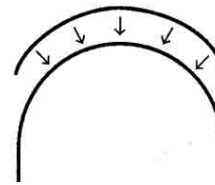

Bend over outside curves.

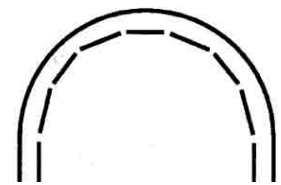

Cut sections for flat curves.

### ADVANTAGES OF THE SPRINGLOC FASTENING SYSTEM:

- Does not pinch, bind or weaken the material it secures.
- Can be formed to top of curved bows.
- Can be secured to any structural members.
- Can be secured to any structural components.
- Can be used to slice poly.
- Can be installed around gable-ends by cutting "V's" out of channel.
- Channel holds two springs for a stronger grip.
- Allow quick film replacement, or changes from one material to another.
- Film can be removed and reinstalled seasonally.
- Does not change holding characteristics, even with repeated use.
- Works by pulling the material across the channel, and inserting the soft spring into place in the bottom of the channel.
- Can hold any flexible material or combination of materials.

Stock No.	Description
260-6022	12' Aluminum Base - Swedged
260-6027	12' Galvanized Steel Base
260-6030	6.5' Plastic Coated Steel Wiggle Wire
260-6035	6.5' Stainless Steel Wiggle Wire
260-6040	Galvanized Splicer for Galvanized Springloc Base

*It is recommended to use two wires per 6' channel.*

*Also recommended to change one of two wires with new wire every 3-4 years when changing poly. For attaching roof poly to gable ends with rigid covering, see Universal Springloc on page 124.*

## BATTEN TAPE



Batten tape is a tough, white vinyl plastic strip used for securing plastic film to wood frames. Simply staple every 3-4 inches keeping tape tight.

Stock No.	Size
225-13/4X1BT	3/4" x 1000'
225-13/4X5BT	3/4" x 500'

## POLYPROPYLENE STRAP / BATTEN TAPE



This strap / batten tape may be used to attach plastic film to wood greenhouse frames or for strapping over greenhouses to secure plastic covering during windy weather. Unlike white vinyl plastic, this

black woven polypropylene batten tape does not become brittle when exposed to sun light.

Stock No.	Size
225-123418BT	2-3/4" x 500 yards (1500')

# GREENHOUSE FILM REPAIR TAPE

Our Greenhouse repair tape is a 6 mil, UV stabilized film with an acrylic adhesive. The paper protective liner prevents tape from bonding to itself. Dependable for patching and protecting polyethylene films.



Stock No.	Size
225-32484-JD	2" x 48'
225-34484-JD	4" x 48'
225-36484-JD	6" x 48'
225-310484JD	10" x 48"
2252002	O Poly Patch 2.75" x 50'
2252004	O Poly Patch 5.5" x 50'

## INFLATION BLOWERS



Use to maintain air space between poly film layers.

60 CFM for round blower. 140 CFM for square blower.

Stock No.	Description
225-34VBM60	Round Mouth
225-34C442DG	Square Mouth

## OUTSIDE AIR INFLATION SYSTEM



Eliminates condensation between film layers, reduces heat loss. Complete kit includes blower, exhaust air deflector and mounting bracket, 72 inch inlet air hose, air inlet damper/air regulator. The inlet hose may be

cut to fit any desired installation length. A special Rigid Cover Kit is available for greenhouses with rigid polycarbonate endwalls (twinwall, corrugated or single panel). Retro-fit kits are available for standard, 60 CFM, adjustable blowers. Retro-fit kits have all parts except the blower.

Stock No.	Description
225-349029JD	Outside Inflation Kit

## AIR DEFLECTOR & BRACKET



Jaderloon's exclusive four-port air deflector reduces film deterioration by directing air away from the poly layer. White cap reduces degradation and eliminates air flow restrictions. Standard positive twist lock allows easy replacement of old style bushing in existing mounting brackets.

Stock No.	Description
225-3599MBJD	Round Bracket & Deflector
225-3699MBJD	Square Bracket & Deflector

## JUMPER HOSE



Use for inflating side and end walls for the greenhouse. Twist-on coupling and flexible hose make installation simple.

Stock No.	Length
225-836JK-KB	36" w/ends



# POLYCARBONATE GREENHOUSE COVERINGS



If you are looking for a high quality polycarbonate sheet which features the latest in product technology and which comes with the kind of personal service you need, consider GE Multiwall or Corrugated sheet! Our polycarbonate sheets are an effective alternative to traditional glazings in a wide variety of applications.

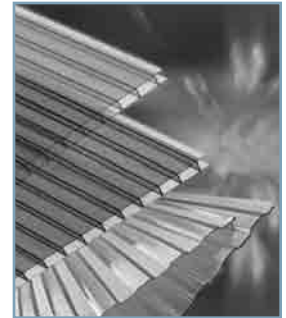

### VIRTUALLY UNBREAKABLE

Polycarbonate is economical and light in weight, yet is 10 times stronger than acrylic and 200 times stronger than glass!



### ANTI-DRIP/ANTI-FOG COATING

This high tech discovery ensures that greenhouse condensation is carried away from the roofing allowing water to spread into a thin sheet rather than form into droplets which would damage your nursery stock.



### EASILY FABRICATED ON SITE

Our highly flexible, polycarbonate sheet can be easily cold formed and will not crack or splinter when fabricated.

### FEATURES:

- High Light Transmission
- 10 Year Warranty
- Harmful Ultra Violet Rays Blocked
- Highly Flexible
- Economical and Light in Weight



## CORRUGATED COVERLITE AN IDEAL GREENHOUSE COVERING

Ideal for Greenhouses and other applications where excellent light transmission is needed in a lightweight sheet. Extensive research and development ensure all corrugated sheets have a high resistance to the harmful effects of weather both in the impact strength to resist hail damage and in UV Protection. Corrugated is available in both clear, opal, bronze and diffused.

### STANDARD SHEET SIZE:

50" Wide x 48' Long. Sheets are available up to 48' and can be custom cut for any greenhouse.



### Maximum Spacing of Purlins and Rafters

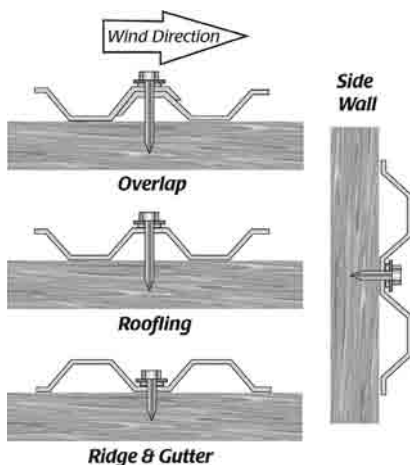
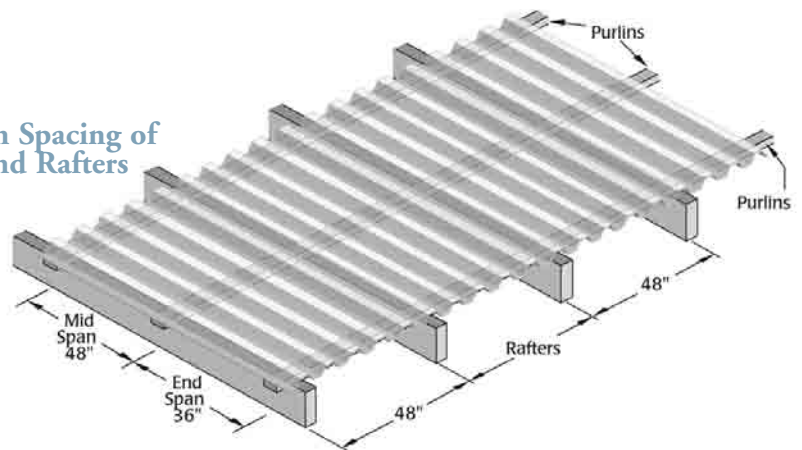

Above, you can see typical fastening. Pay particular attention to the prevailing winds when determining overlap direction for a more effective seal against moisture penetration.

NAME	OVERALL WIDTH	OVERALL LENGTH	NET COVERAGE	PITCH	DEPTH	THICKNESS
GRECA	26" & 50"	UP TO 39'	24" & 48"	3"	0.70"	0.031"
RIDGE CAP	24"	10'6"	-	-	-	0.047"

*Call for pricing and availability. Quantity discounts may be applicable. Large orders ship F.O.B. factory. Crating charges apply.*



# POLYCARBONATE GREENHOUSE COVERINGS

**Lexan Thermoclear Plus** has proprietary UV protection, giving superior resistance to outdoor weathering. Some things are meant to change their color by season but not your glazing! According to accelerated 4,000 hours weathering tests that have been carried out at GE Advanced Materials Laboratories, Lexan Thermoclear Plus sheeting is superior to other available polycarbonate multiwall glazing products. Thermoclear Plus sheeting offers a ten year limited written warranty against discoloration, loss of light transmission (it will not lose more than 2% light transmission over 10 years) and loss of impact strength due to weathering.



## BROAD DESIGN FREEDOM

**With UV Protection on one side and Anti-Drip Protection on the other!**

Lexan Thermoclear Plus multiwall sheeting is UV-protected on both surfaces. It offers wide design flexibility as well as important advantages in both cutting and installation.



## HEAT MANAGEMENT - Thermoclear Solar Control

With Thermoclear Solar Control IR multiwall sheeting, proprietary resin additives are used to manage heat instead of expensive and fragile coatings, which can be damaged during handling and installation. This innovative solar control glazing product significantly reduces solar transmission while simultaneously offering high levels of light transmission, helping save energy costs for cooling and lighting buildings.

### MAXIMUM SPACING OF PURLINS (IN.) (1" DEFLECTION ON 48" FIZED WIDTH)

Load (psf)	8mm
15	38
25	30
35	23
45	18

## STANDARD SHEET SIZES

- 4' wide x 39' long x 8mm thick
- 6' wide x 39' long x 8mm thick

## COLD FORMING

8mm can cold from to a radius of 55"

**AVAILABLE COLORS** - Clear.

# TWINWALL SHEETING



PROPERTIES			
Standard Widths (in.)	48", 72", & 83"		
Spacing Between Flutes (mm)	10		
Light Transmission			
Tints:			
Clear	C1		80%
Opal	C9		40%
White	C9		20%
Bronze	C2		30%
Dark Bronze	C2		15%
Gray	C4		30%
Blue	C5		50%
Green	C7		50%
Insulation: R-Factor	1.64		
U-Factor (BTU/hr.ft <sup>2</sup> /°F)	0.61		



**Verolite Polycarbonate Twinwall Sheet**, the perfect glazing alternative for any greenhouse application, translates its many unique features into cost saving benefits. One of the heaviest twinwall sheets.

## FEATURES:

- High Light Transmission
- 10 Year Warranty
- Harmful Ultra Violet Rays Blocked
- Highly Flexible
- 200 Times Stronger Than Glass
- Easily Fabricated

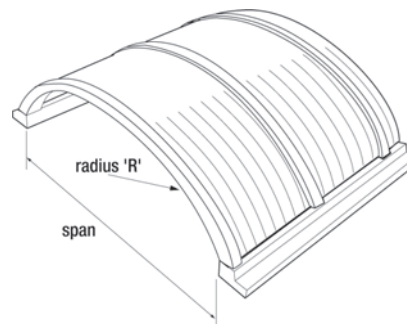

## ARCH BENDS

The table below suggests a minimum bend diameter for cold forming Verolite sheets in an arched application. 8mm can cold form to 5.3 feet! Sheets are available up to 48' and can be custom cut for any greenhouse.

### STANDARD SHEET SIZES

- 4' X 8'
- 4' X 10'
- 6' X 8'
- 6' X 10'
- 6' X 12', 6' X 14', 6' X 16',

(UP TO 39" LONG BY SPECIAL ORDER.)



## AN IDEAL GLASS REPLACEMENT

Solid Coverlite is ideal for vents, doors, retail garden centers, and anywhere a strong, durable, lightweight and safe replacement for glass is needed.

## AVAILABLE COLORS

Clear, bronze, opal, gray, green, blue and embossed.

# SOLID COVERLITE

*Call for pricing and availability. Quantity discounts may be applicable.  
Large orders ship F.O.B. factory. Crating charges apply.*





# ACCESSORIES

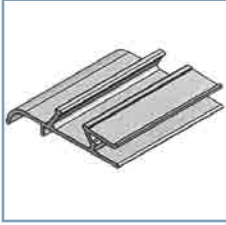

### UNIVERSAL VENT RAIL

The Universal Vent Rail is designed for both the sides and the bottom of the vent and will accommodate either 8mm PCSS or poly covering for the vent. When used with the Universal Slam Rail and the Slam Rail, it creates an air and watertight seal around the rail.

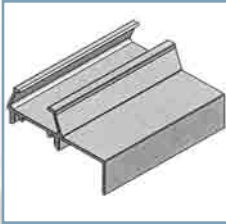

### UNIVERSAL SPRING LOCK

Universal Spring Lock easily neatly and inexpensively finishes gable end walls covered with PCSS. It securely attaches poly and shade cloth to any round or square tubing and allows for 8mm polycarbonate or raised rib sheets under its cap. Stock size is 12' other lengths available as custom orders.

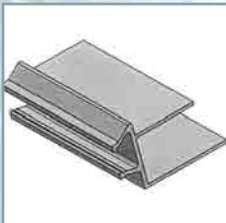

### POLY VENT SPRING LOCK

Used at the bottom edge of a poly vent. Unique position of channel allows water to pass over vent seal area. Fits 1-1/4" square steel vent arms.

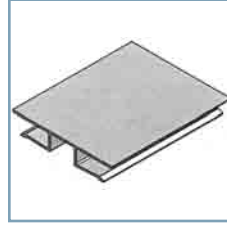

### H PROFILE LARGE

Use the 8mm aluminum Large H Profile to splice two pieces of polycarbonate together on any flat surface, recommended for vertical walls and not roofs. Stock length 12' other lengths available as custom orders.

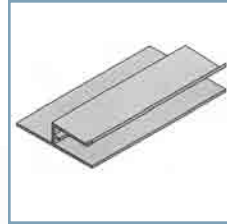

### H PROFILE SMALL

Use the 8mm aluminum Small h Profile to attach and seal edges of polycarbonate to a structure. The Small h Profile can be attached to most steel greenhouse frames with #10x1" tek screws. 12' lengths are in stock, other lengths available upon request.

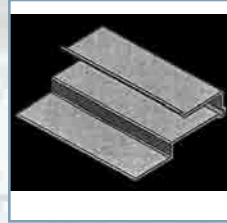

### ALUMINUM U CHANNEL

Use Aluminum U channel with Bar Base profiles to seal perimeter edges of polycarbonate. Available in 12', other lengths available upon request.

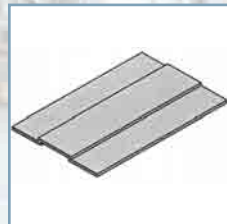

### BAR BASE & BAR CAP

Use together to form a two-piece profile similar to the Large H Profile for connecting sides of polycarbonate sheeting. This profile is used in roof application for structural support between purlins and eliminates leakage when compared to the Large H Profile applications. Use Aluminum U channel for framing out and sealing open ends of polycarbonate. Secure Bar Base to greenhouse frame and attach Bar Cap to Bar Base with #10 x 5/8" self tapping hex head screws. Stock length 12', other lengths available as custom order.

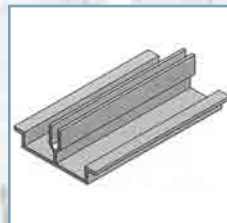

Stock No.	Description
<b>POLYCARBONATE PROFILE</b>	
215-28MMHPPG	H Profile 8mm 24'
215-28MMUPPG	U Profile 8mm 12'
<b>ALUMINUM EXTRUSIONS</b>	
215-290204	Small H Aluminum Profile 12'
215-290404	Large H Aluminum Profile 12'
215-290808	26' Bar Cap Aluminum Profile
215-290814	20' Bar Base Aluminum Profile
215-291100	12' Universal Vent Rail
215-291202	12' Universal Spring Lock
215-291210	12' Poly Vent Spring Lock
215-290608	12' Aluminum U Channel
<b>TAPE</b>	
21525040	Aluminum Solid Foil Tape 1' x 165'
21525045	Vent tape 1" x 328'

Stock No.	Description
<b>HARDWARE</b>	
21525001	#12 x 1" Self Tapping Screw w/Seal
21525002	#12 x 1-1/2" Self Tapping Screw w/Seal
21525003	#12 x 2" Self Tapping Screw w/Seal
21525010	#12 x 1-1/2" Self Tapping Screw
21525011	#12 x 2" Self Tapping Screw
260-2DPS58JD	#10 x 5/8" Self Tap Screw (for metal)
260-2SSS01JD	#10 x 1" Stainless Steel Drill Point Screw (for wood)
2601102	#12 x 1" Hex Head Tek Screw galvanized
2601104	#12 x 1-1/2" Hex Head Tek Screw galvanized
21525020	#9 x 1" Woodgrip Screw w/Seal
21525021	#9 x 1-1/2" Woodgrip Screw w/Seal
21525022	#9 x 2" Woodgrip Screw w/Seal
260-20001	#14 x 1" Self Drill Hex Washer Head - Zinc Plated Screw
260-20002	#14 x 1-1/2" Self Drill Hex Washer Head - Zinc Plated Screw
215-21ALNEPG	1" Aluminum Neoprene Washer (100/Bag)